

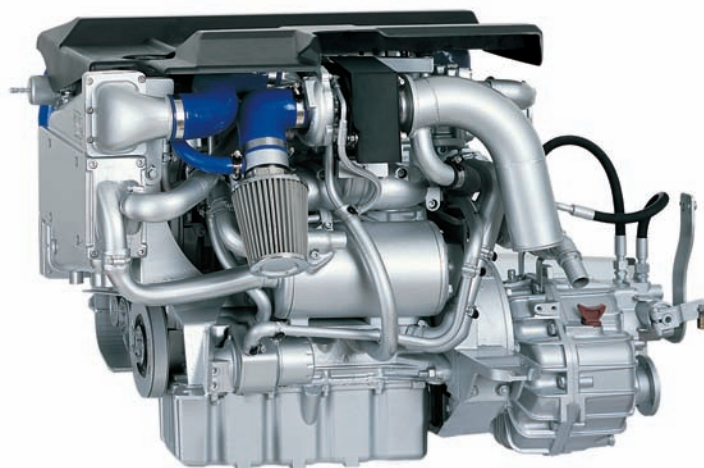

MARINE DIESEL ENGINES



FNM HPE 170

Configuration	4-stroke cycle, twin camshaft, 16 V
Maximum output at crankshaft	125 kW/170 hp at 4000 rpm
Maximum torque	338 Nm at 2200 rpm
Displacement	1.910 c.c.
Bore x stroke	82 x 90,4 mm
Cylinders	4, in-line
Combustion system	Direct injection Common rail
Aspiration	Supercharged with variable geometry turbo
Starting system	Electric starting 12 V – 2,1 kW
Alternator	14 V – 105 A
Cooling system	Double water cooling system with heat exchanger
Lubrication system	Totally enclosed, forced lubricating system with pump
Max. mounting inclination	14°
Dry weight without gear	240 kg
Environmental	Meets the EU comprehensive emissions regulation 2006
Engine mounting	Rubber type anti-vibration mounting

Performance Curves (Output is according to ISO 8665)

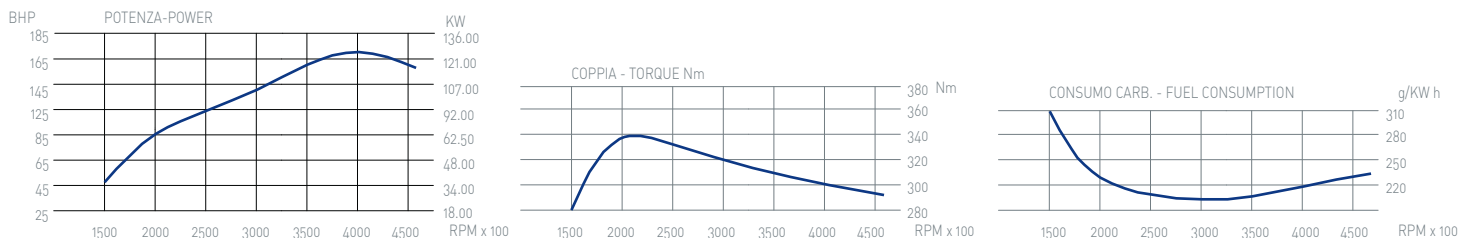

Dimensions (For detailed line-drawings, please refer to our website www.fnm-marine.com or contact your supplier)

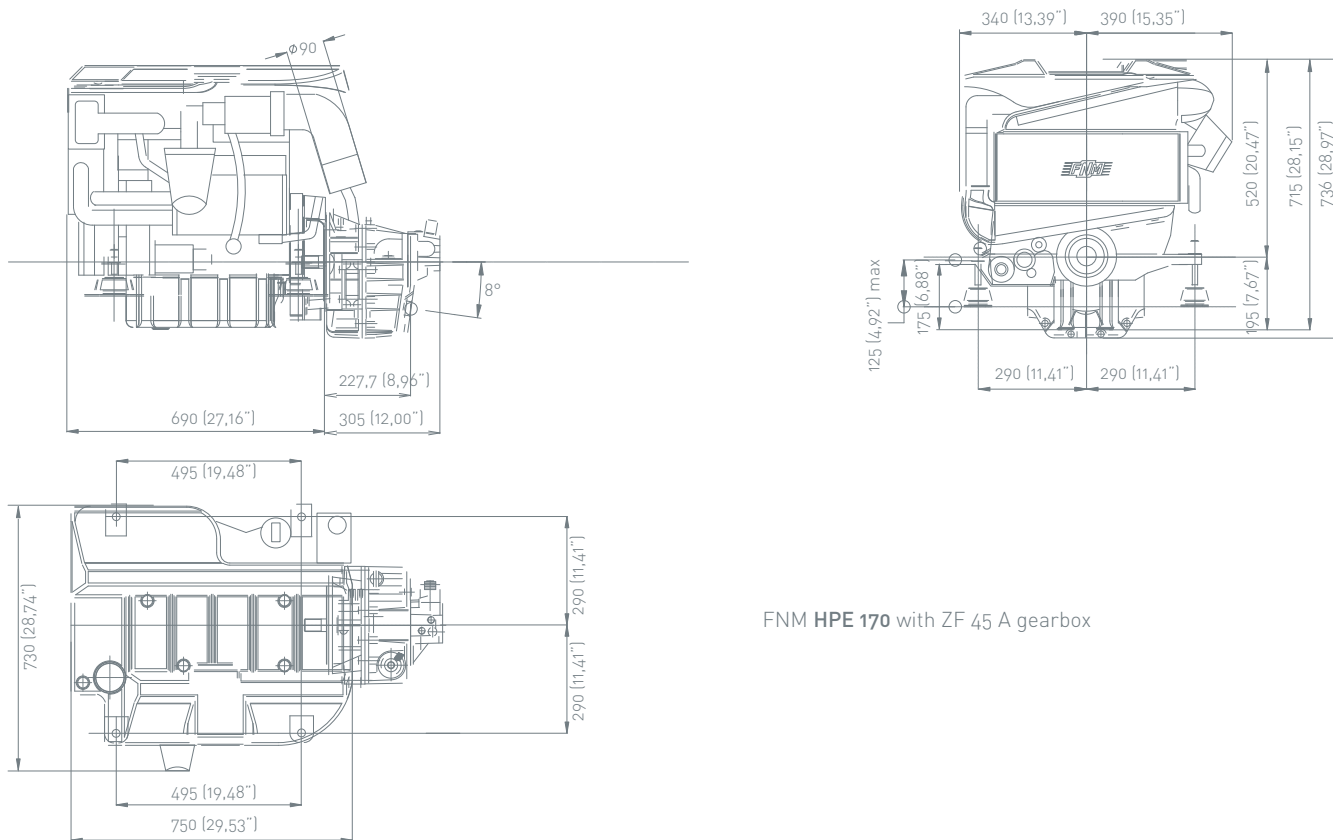

FNM HPE 170 with ZF 45 A gearbox

Instrument Panel

- VDO Oil pressure
- VDO Water temperature
- VDO Voltmeter
- VDO Rpm counter
- 8 meter cable

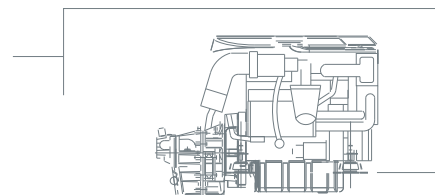

Accessories

Standard Package

- Gearbox
- Set of flexible mounts
- Alternator 14 V - 105 A with built-in regulator
- Starter motor 12 V - 2,1 kW
- Oil and fuel filters
- Stainless steel seawater-cooled elbow

- Racor filters
- Instrument panel with 8 mt. cable
- Bronze seawater pump
- Engine top cover
- Water-cooled exhaust manifold

Optional

- Kit for boat internal heating
- 2 mt. auxiliary extension cable
- Flybridge instrument panel

- Kit for coupling to Mercruiser and Volvo stern drives
- Trolling valve
- 2-groove front pulley

Text and illustrations are not binding. CMD, owner of the FNM brand, reserves the right to introduce adaptations without prior notification. Compliant with the RCD 2003/44/CE and EPA emission standards.

